

HDM 45-A

ACTIVE TWO-WAY SPEAKER

DESCRIPTION

The HDM 45-A speaker boosts the performance with a top-quality two channel amplifier, RDNet networked management, RCF precision transducers, the FIRPHASE processing, and a rugged cabinet. While being one of the most powerful speakers in composite material in its category, it delivers clear, detailed and smooth sound from low to very high levels, with low distortion and fast transient response. The HDM concept is inspired by the touring industry, packing in an elegant and lightweight cabinet the maximum reliability and strength for intensive use on the road. Perfect as a main front of house speaker in PA systems, high-powered floor monitor, or unobtrusive infill system when combined with the RCF HDL System speakers.



FEATURES

- 133 dB Max SPL
- 2200 Watts two-way power
- Innovative DSP Processing with FIRPHASE
- 650 Hz crossover point for perfect vocal reproduction
- 15" Neodimium Woofer, 3.5" v.c.
- 1.5" Titanium Compression Driver, 4.0" v.c. Neodimium
- 90°x60°, wide dispersion constant directivity horn
- RDNet compatible
- Silent Fanless Class-D Amplifier
- Ultra-Light weight

TECHNICAL SPECIFICATIONS

Acoustical specifications	Frequency Response:	45 Hz ÷ 20000 Hz
	Max SPL @ 1m:	133 dB
	Horizontal coverage angle:	90°
	Vertical coverage angle:	60°
Transducers	Compression Driver:	1.5" neo, 4.0" v.c
	Woofer:	15" neo, 3.5" v.c
Input/Output section	Input signal:	bal/unbal
	Input connectors:	XLR, RDNet Ethercon
	Output connectors:	XLR, RDNet Ethercon
	Input sensitivity:	-2 dBu/+4 dBu
	Mic. Input Sensitivity:	-32 dBu
Processor section	Crossover Frequencies:	650 Hz
	Protections:	Thermal, HF
	Limiter:	Fast Limiter
	Controls:	proces., 8 sel. presets
	RDNet:	Yes
Power section	Total Power:	2200 W Peak, 1100 W RMS
	High frequencies:	600 W Peak, 300 W RMS
	Low frequencies:	1600 W Peak, 800 W RMS
	Cooling:	Convection
	Connections:	Powercon IN/OUT
Standard compliance	EN54-16 certified:	Yes
	CE marking:	Yes
Physical specifications	Cabinet/Case Material:	PP Composite
	Hardware:	1 x M10 top, 1 x M10 bottom, 2 x M10 side
	Handles:	1 Top, 2 Side
	Pole mount/Cap:	Yes
	Grille:	Steel
	Color:	Black
Size	Height:	714 mm / 28.11 inches
	Width:	442 mm / 17.4 inches
	Depth:	397 mm / 15.63 inches
	Weight:	22 kg / 48.5 lbs
Shipping informations	Package Height:	750 mm / 29.53 inches
	Package Width:	440 mm / 17.32 inches
	Package Depth:	480 mm / 18.9 inches
	Package Weight:	24.5 kg / 54.01 lbs



PART NUMBER

- **13000593**

HDM 45-A

EAN 8024530016791

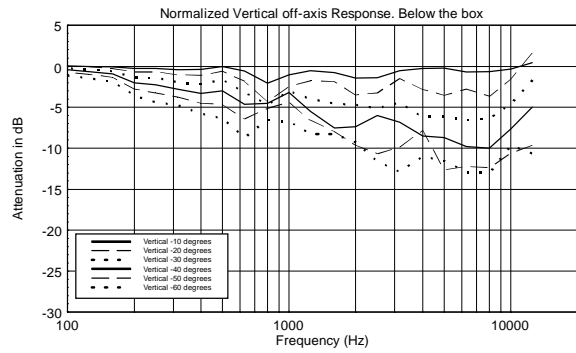
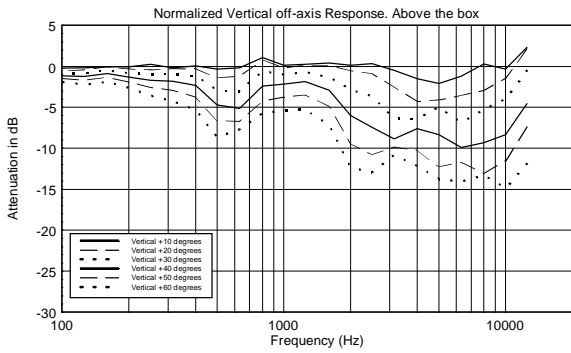
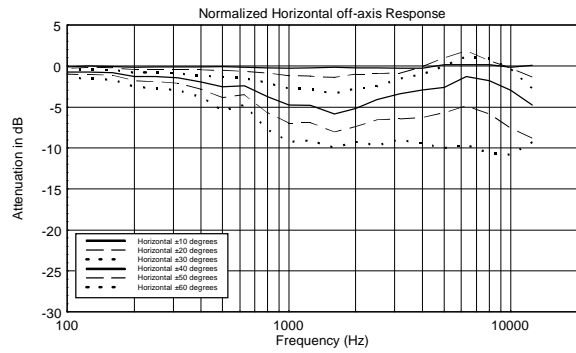
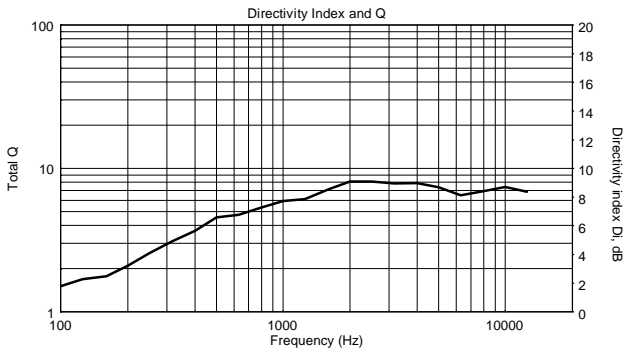
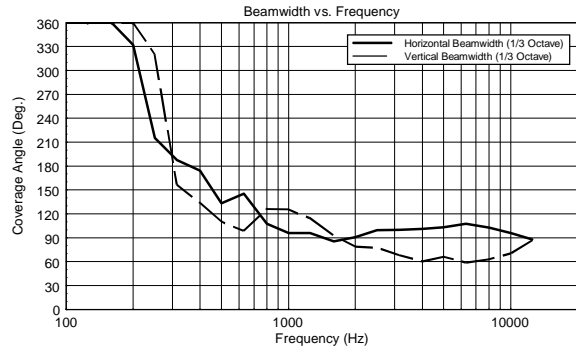
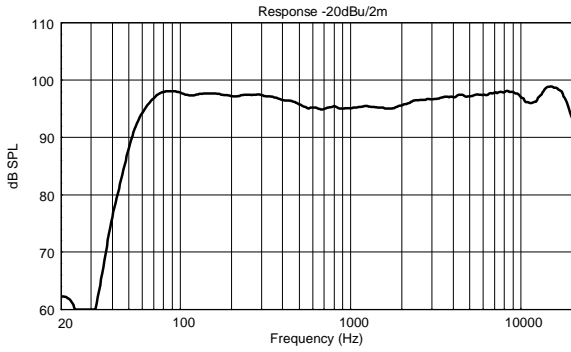

Horizontal 1/3 Octave Polars

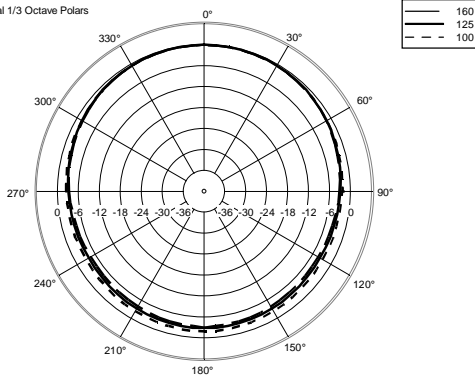

Horizontal 1/3 Octave Polars

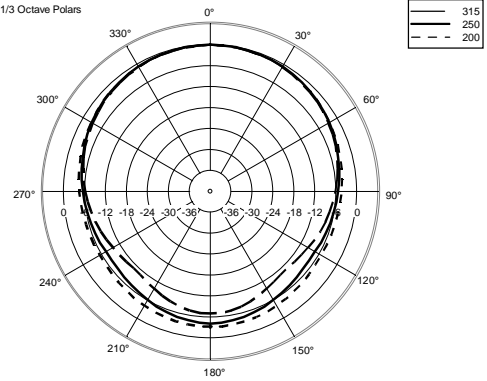

Horizontal 1/3 Octave Polars

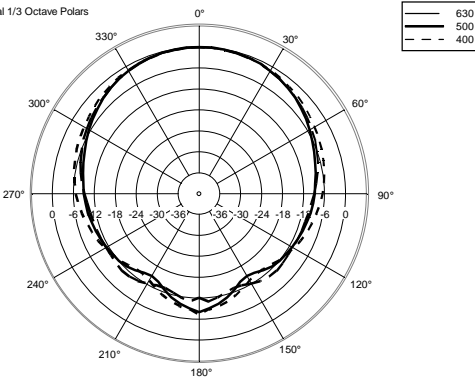

Horizontal 1/3 Octave Polars

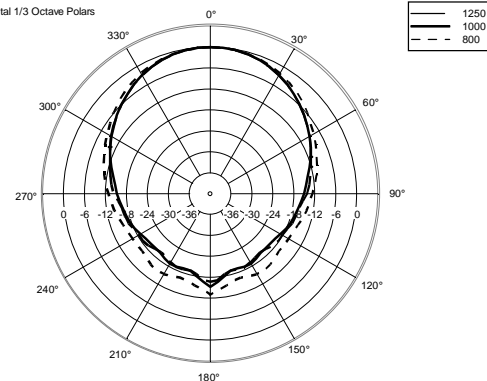

Horizontal 1/3 Octave Polars

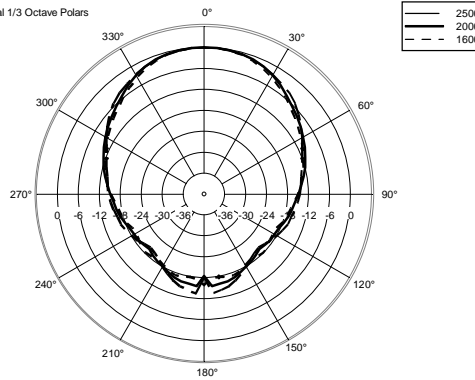

Horizontal 1/3 Octave Polars

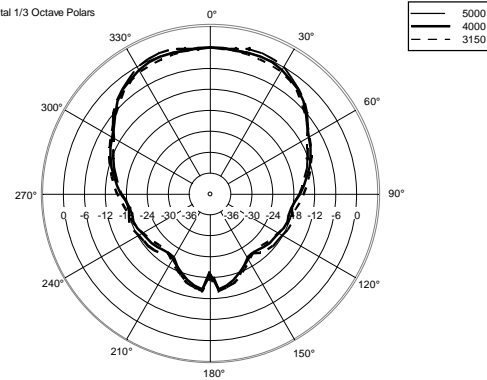

Horizontal 1/3 Octave Polars

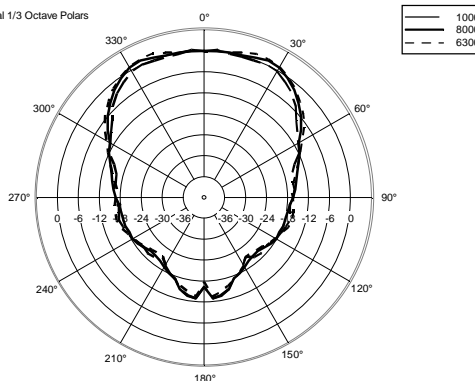

Horizontal One Octave Polars

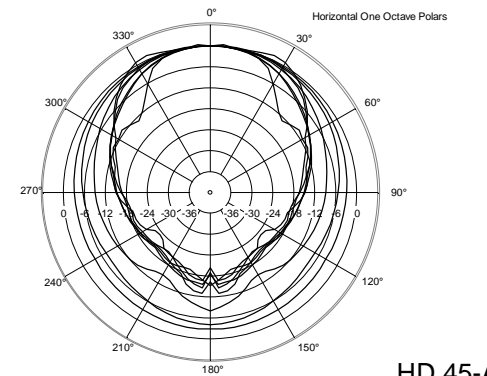

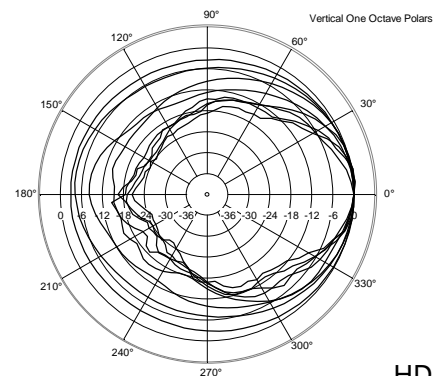
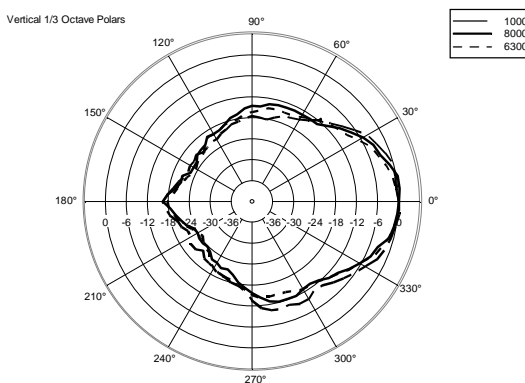
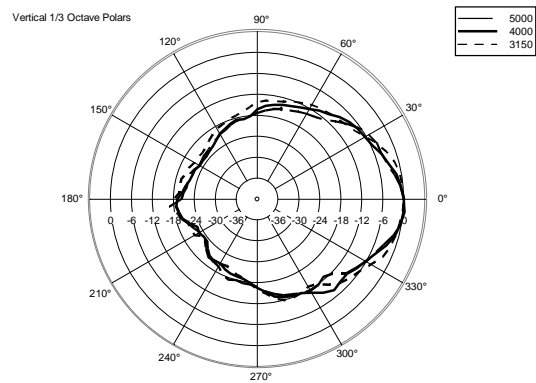
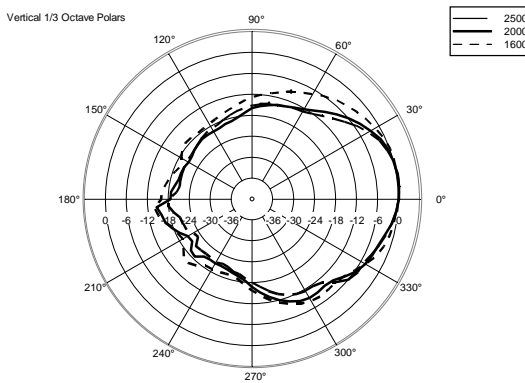
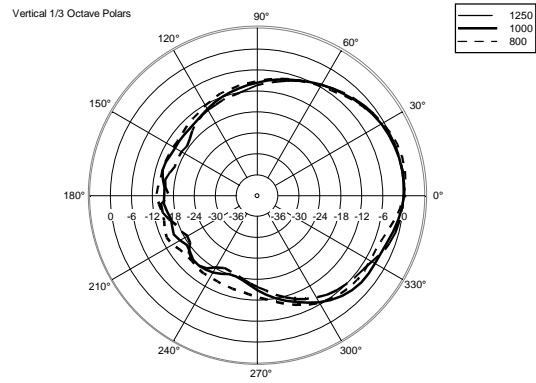
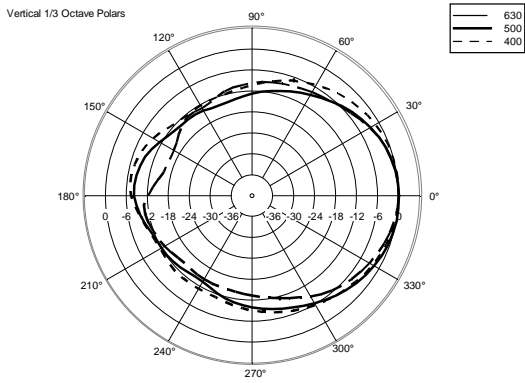
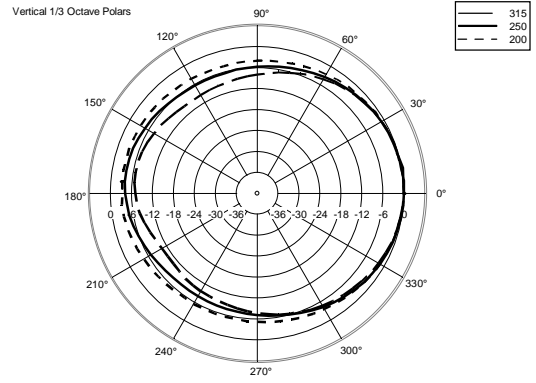
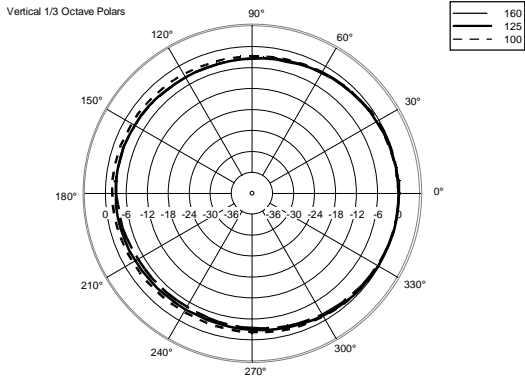

ACCESSORIES



COVER CVR HD 15

PART NUMBER: **13360438**

EAN: 8024530016708
